







GESCHICKT EINGEFÄDELT

Männerjogginghose

Design © Tower Productions 2015

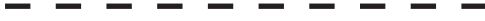
Nur für den privaten Gebrauch.

S 
M 
L 
XL 

TESTQUADRAT
10 cm × 10 cm

1A



1B

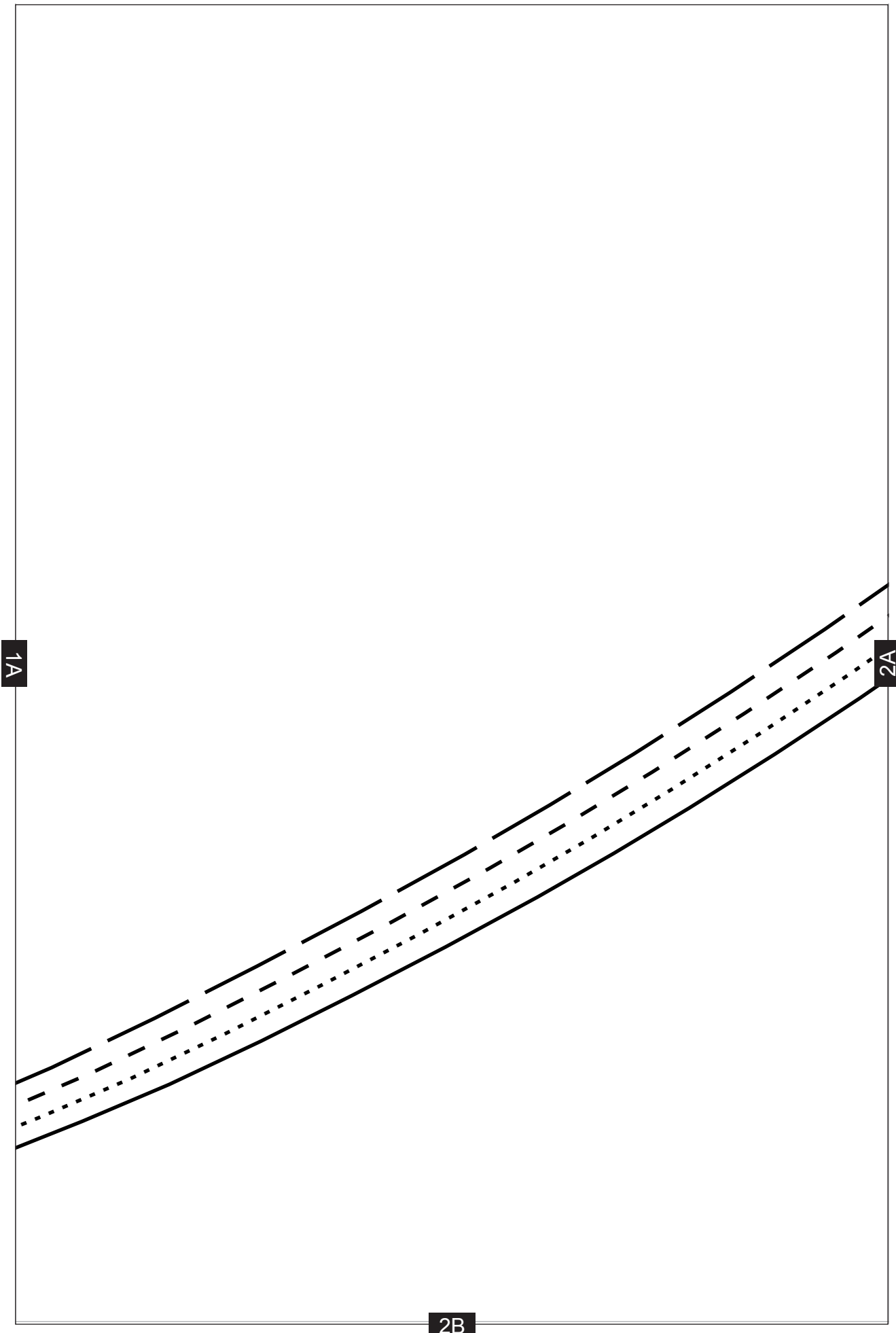

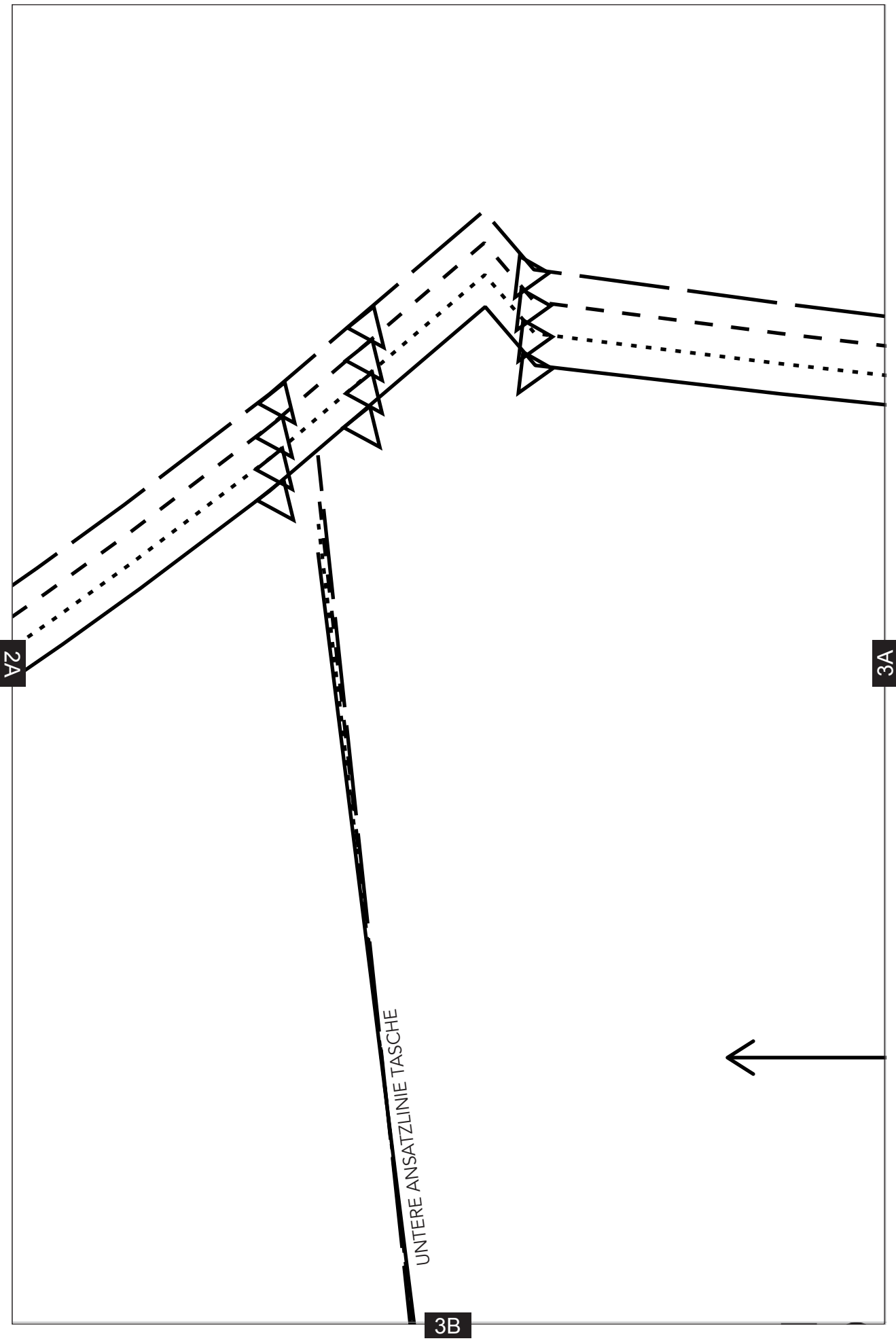

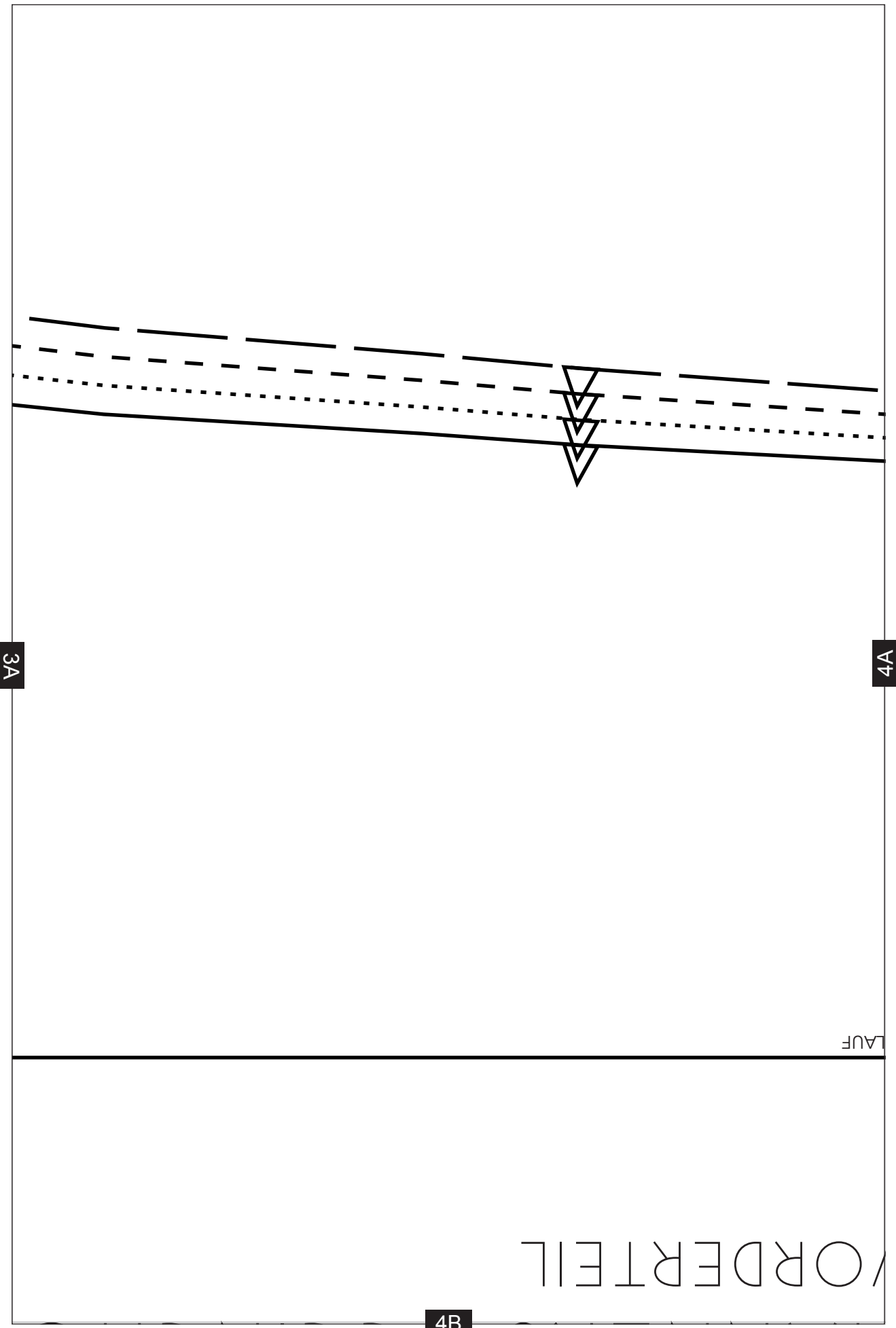

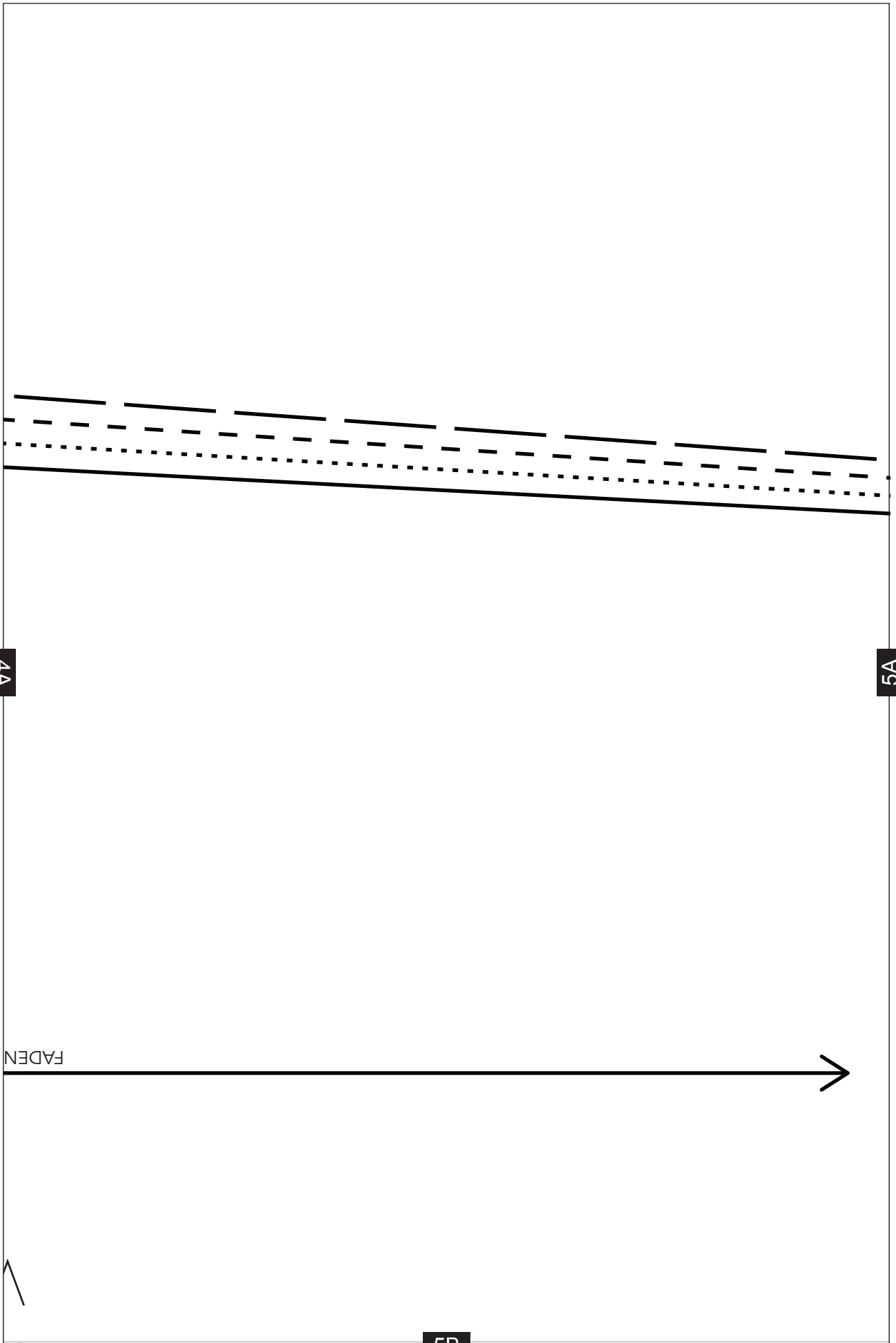

4A

5A

5B

FADEN

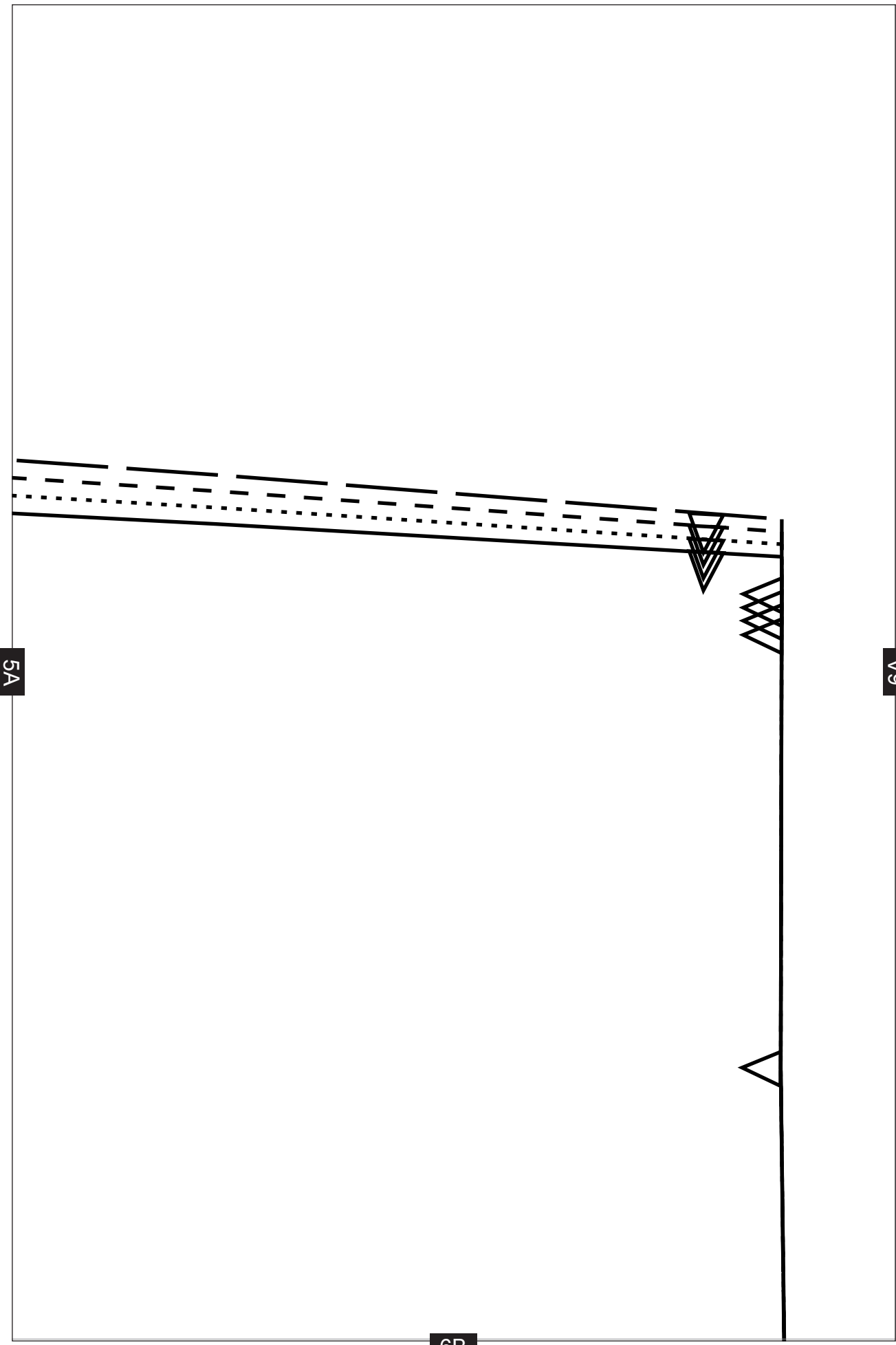

5A

6A

6B

6A

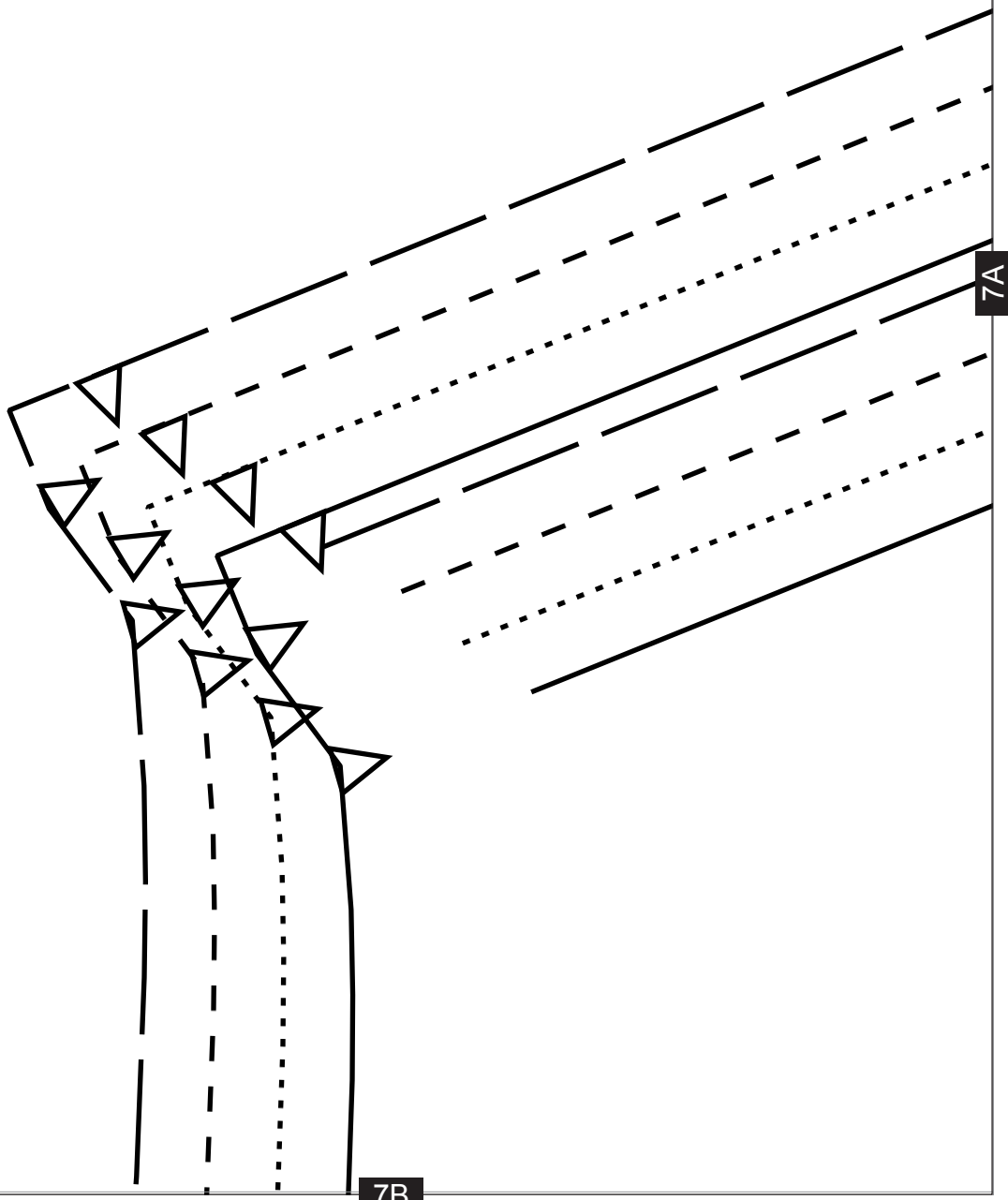

7A

7B

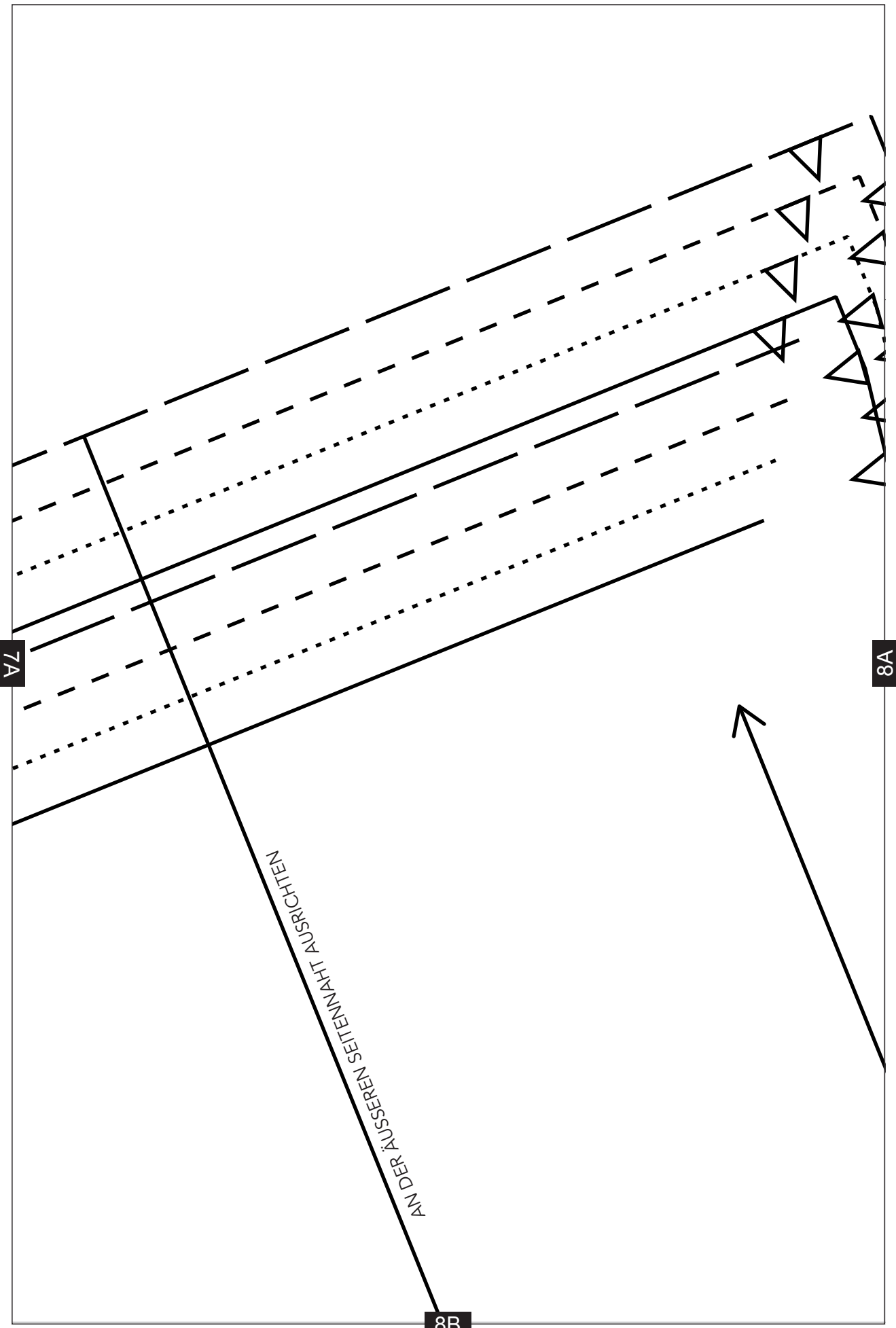

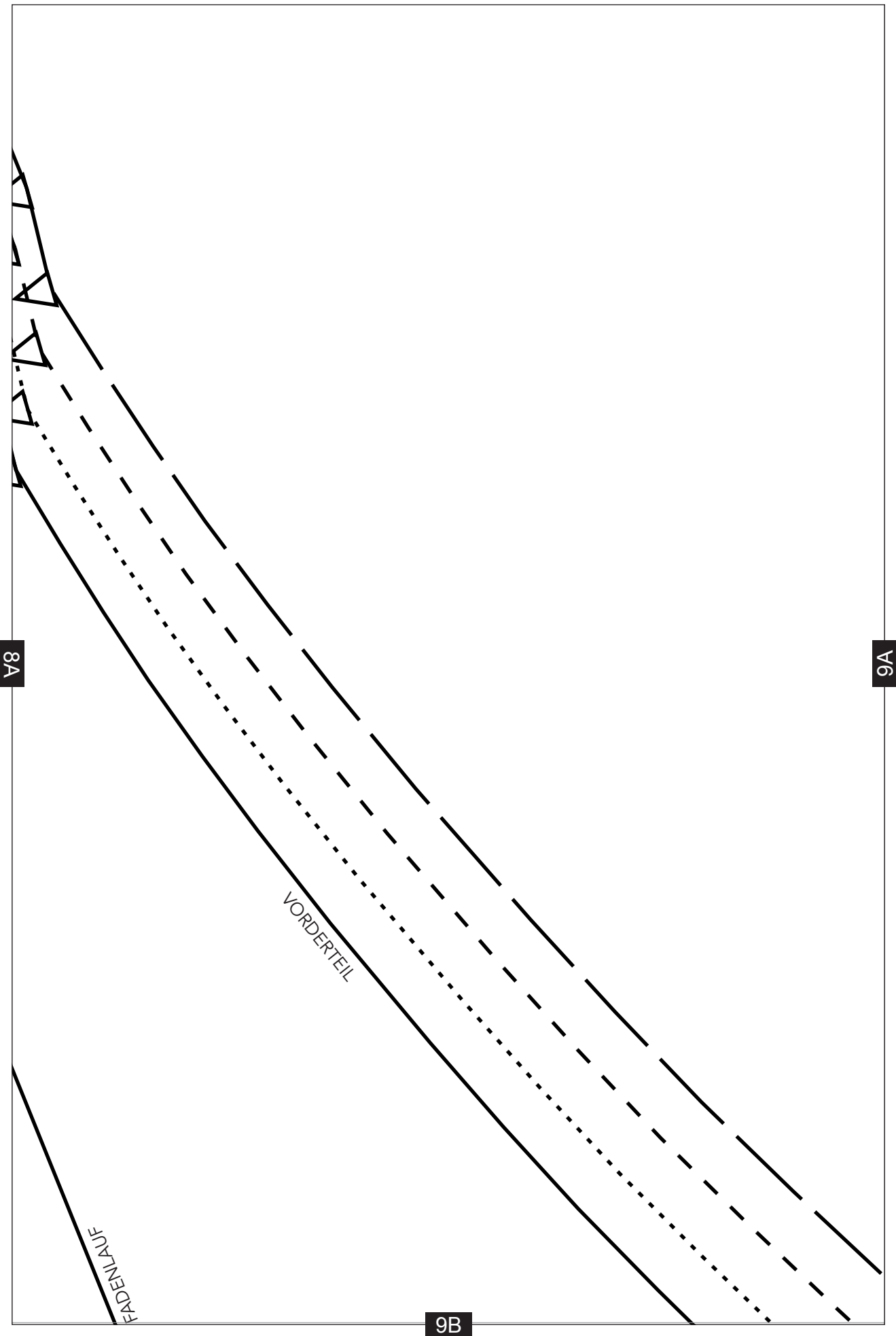

9A

10B

1B

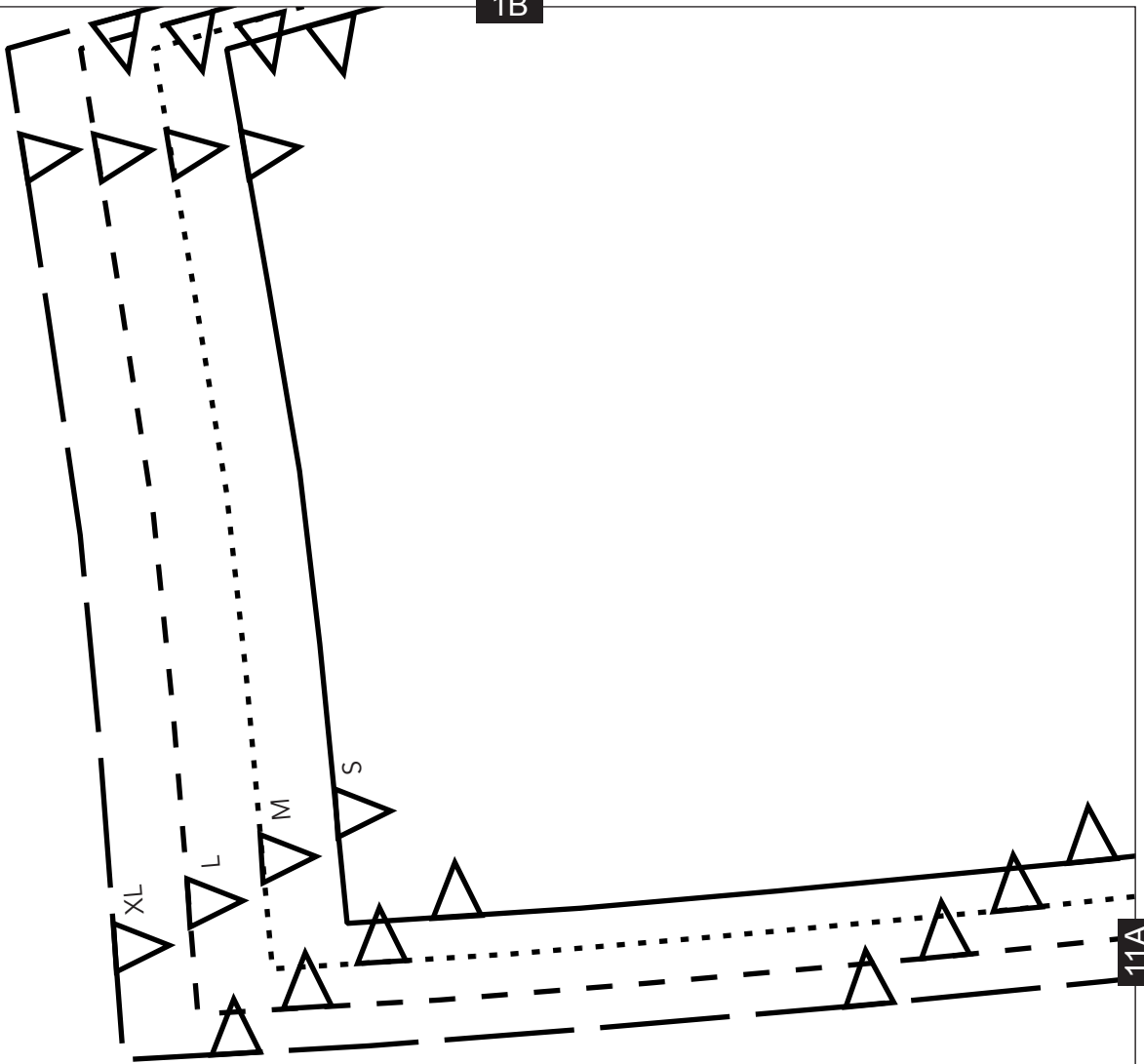

11A

11B

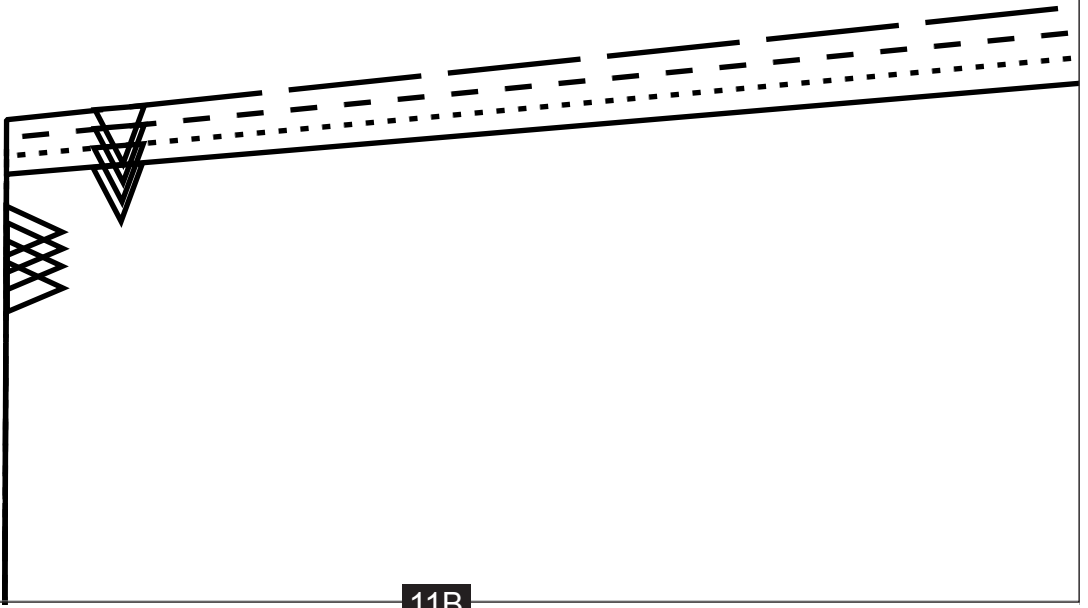

2B

11A

12A

12B

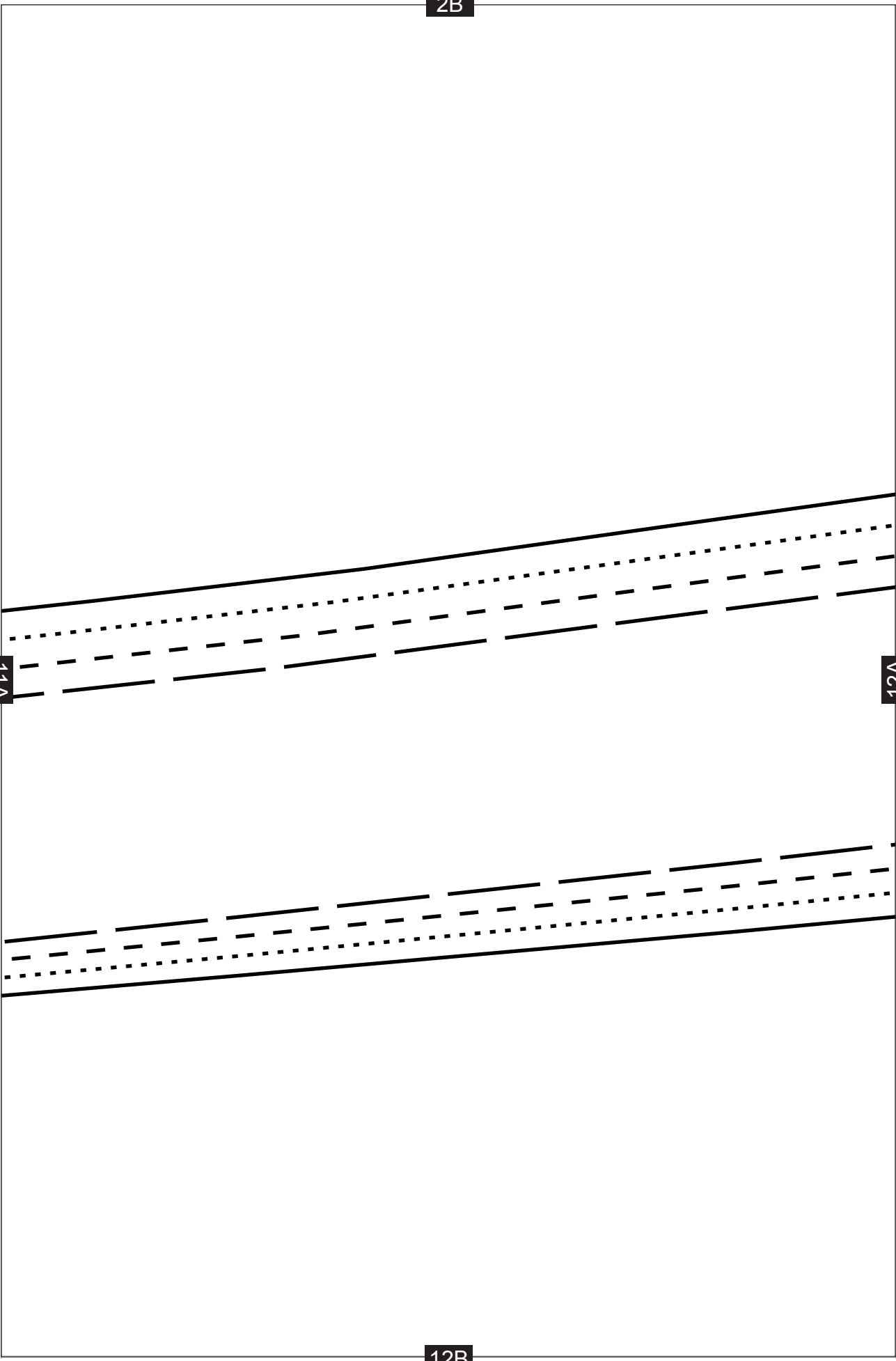

SE

3B

12A

13A

13B

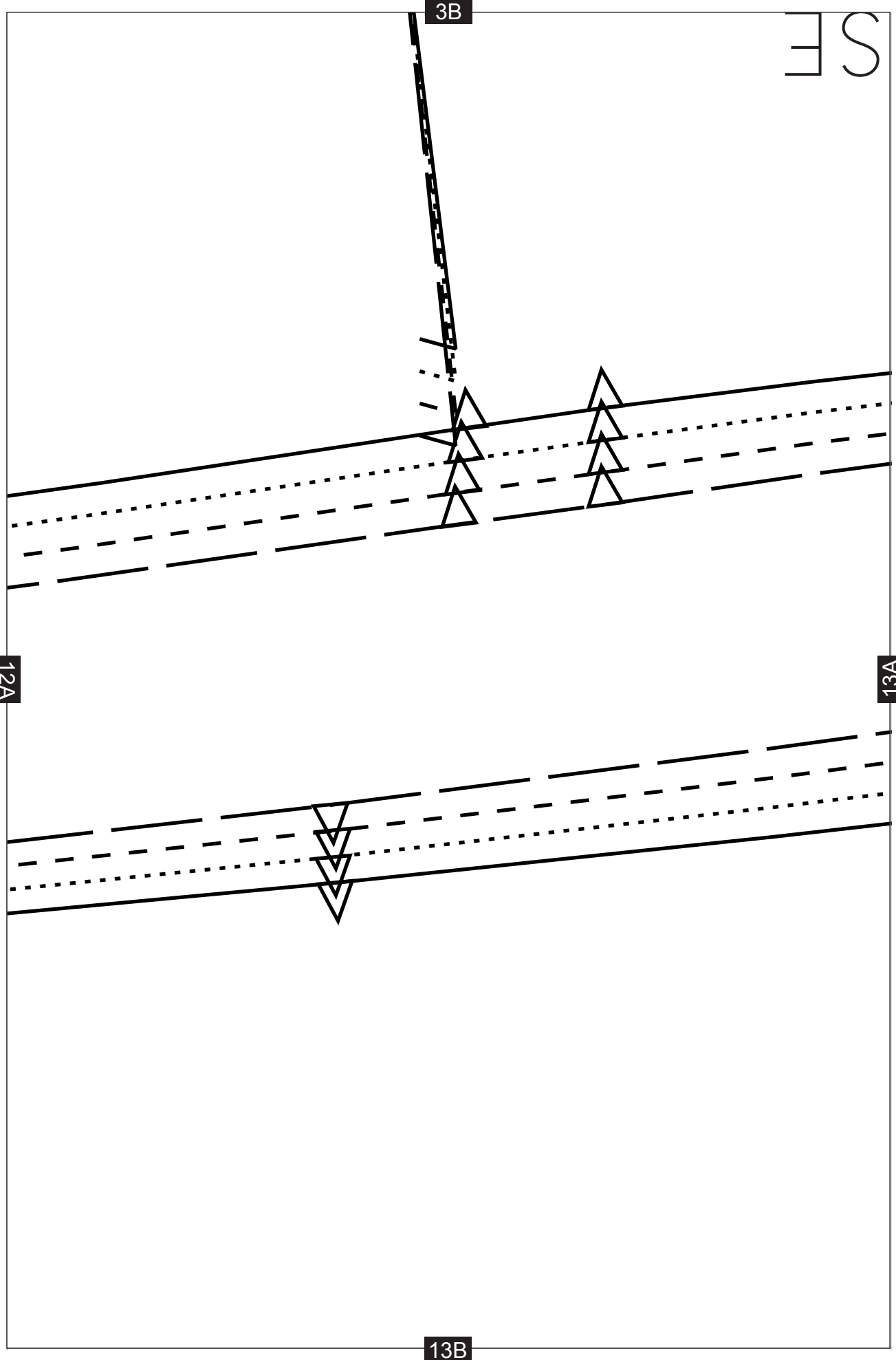

MÄNNER JOGGINGHO

4B

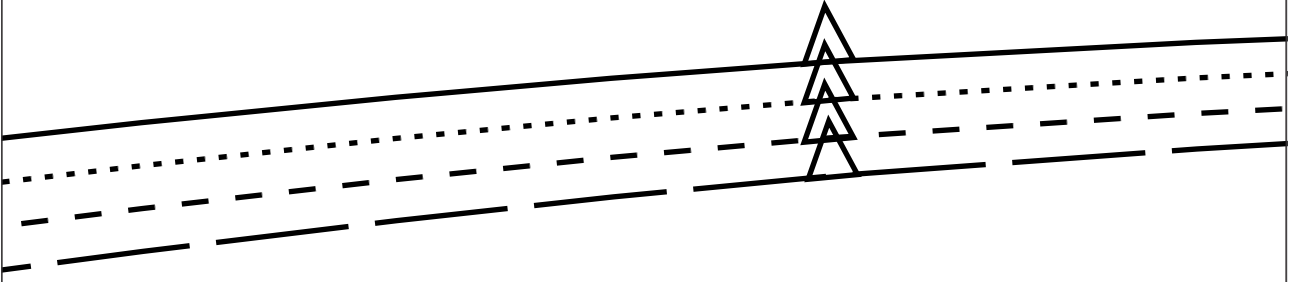

13A

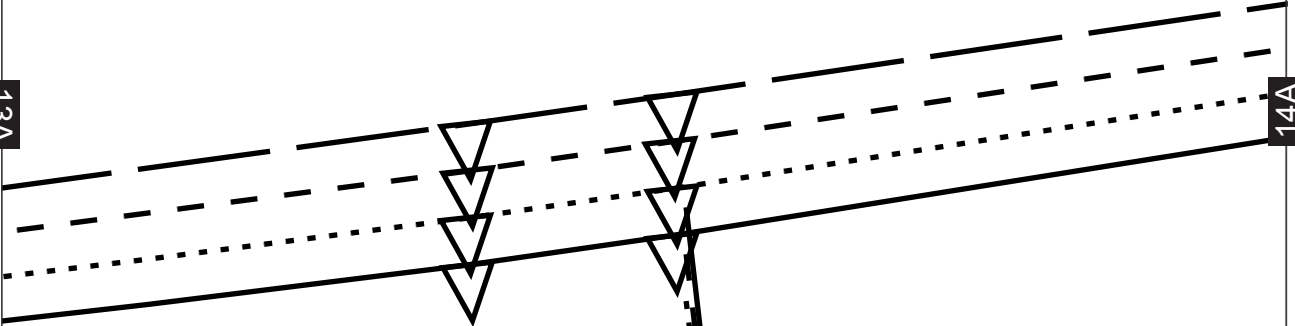

14A

14B



5B

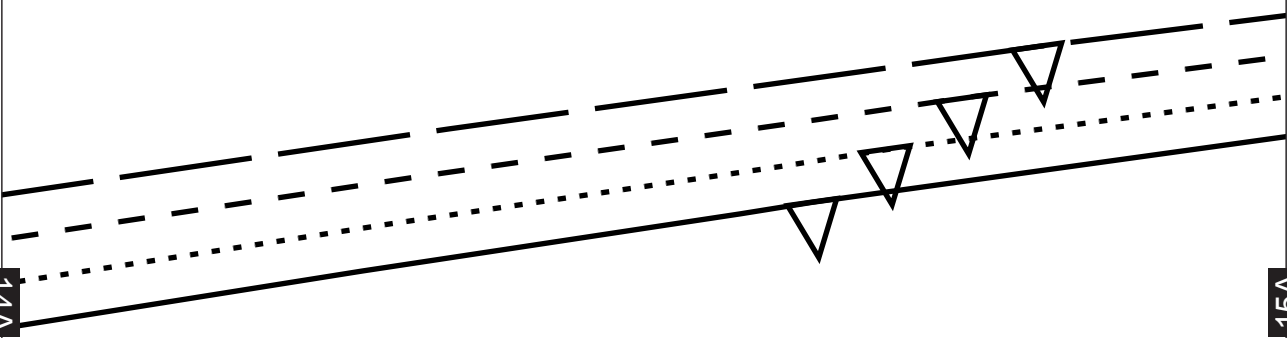
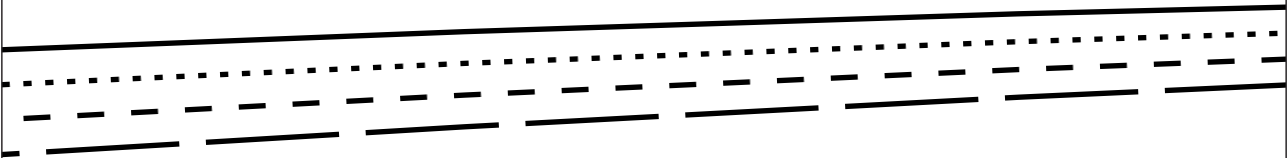

14A

15A

15B

6B

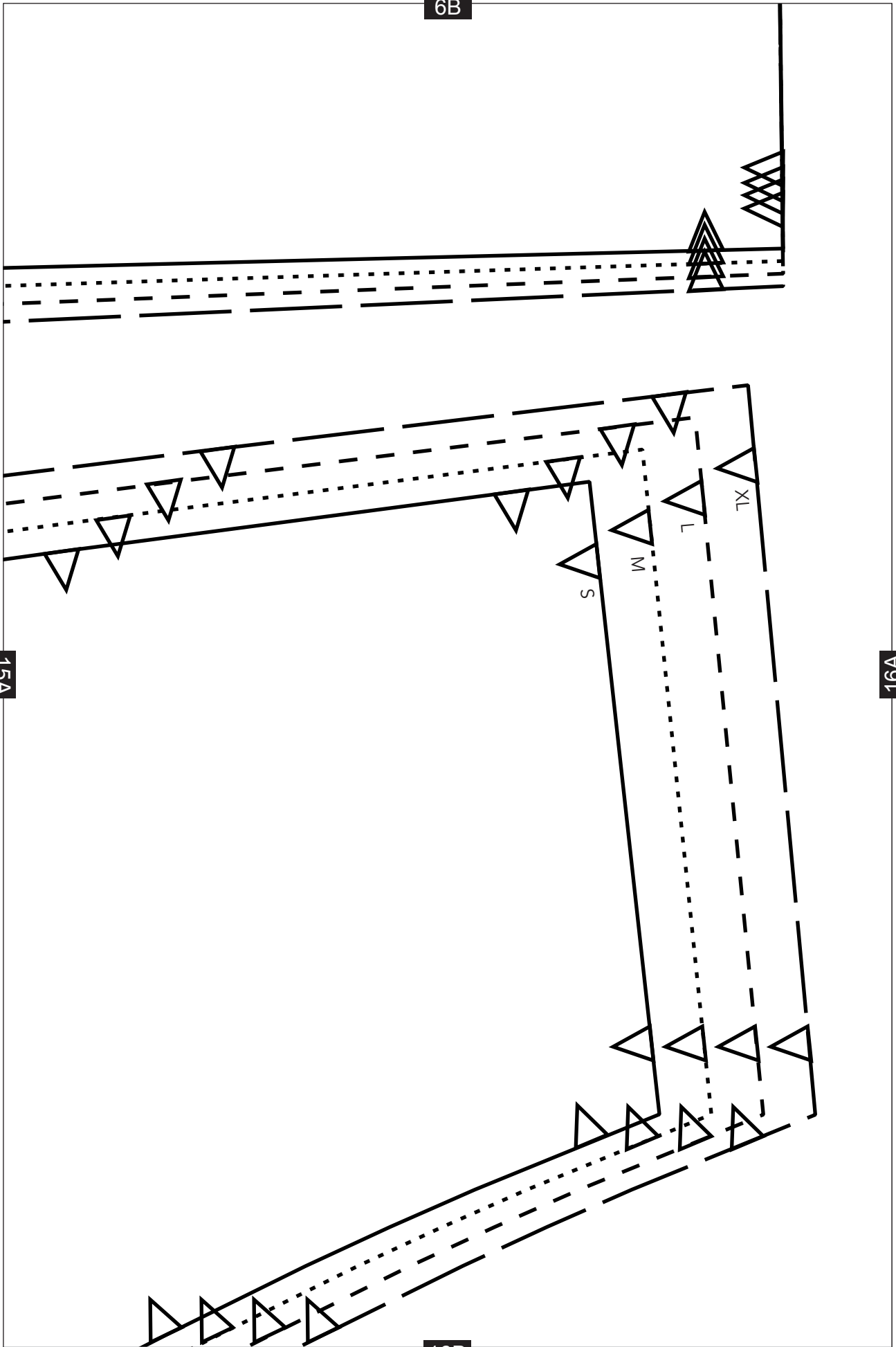

15A

16A

16B

16A

7B

RÜCKENTEIL

17A

MÄNNERJOC
TASCHE

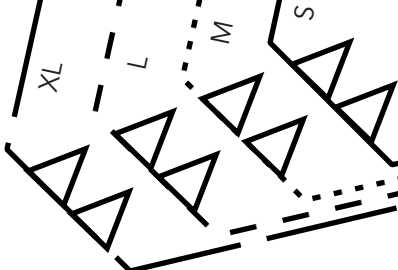

17B

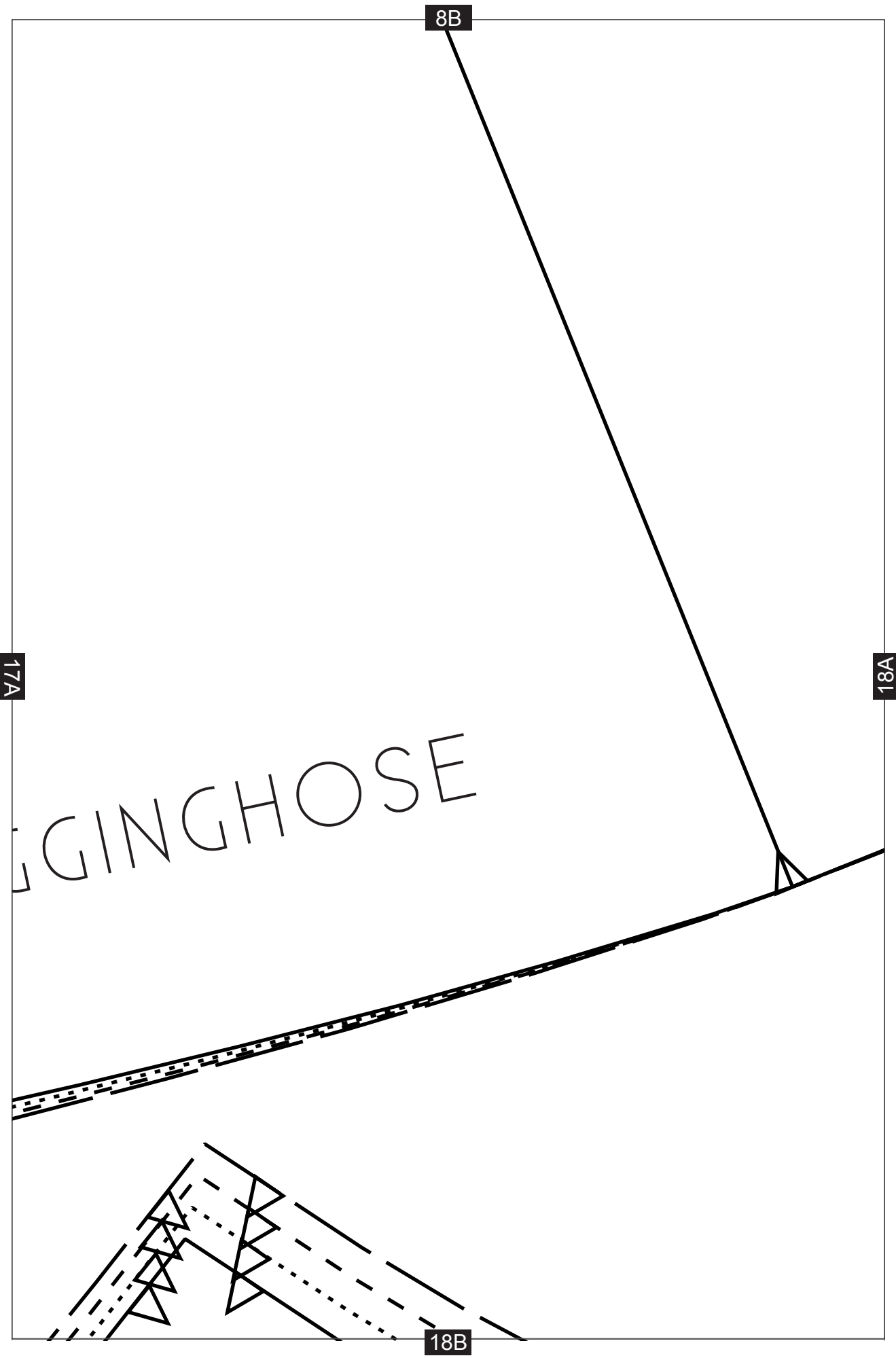

8B

17A

18A

GINGHOSE

18B

9B

18A

19A

19B

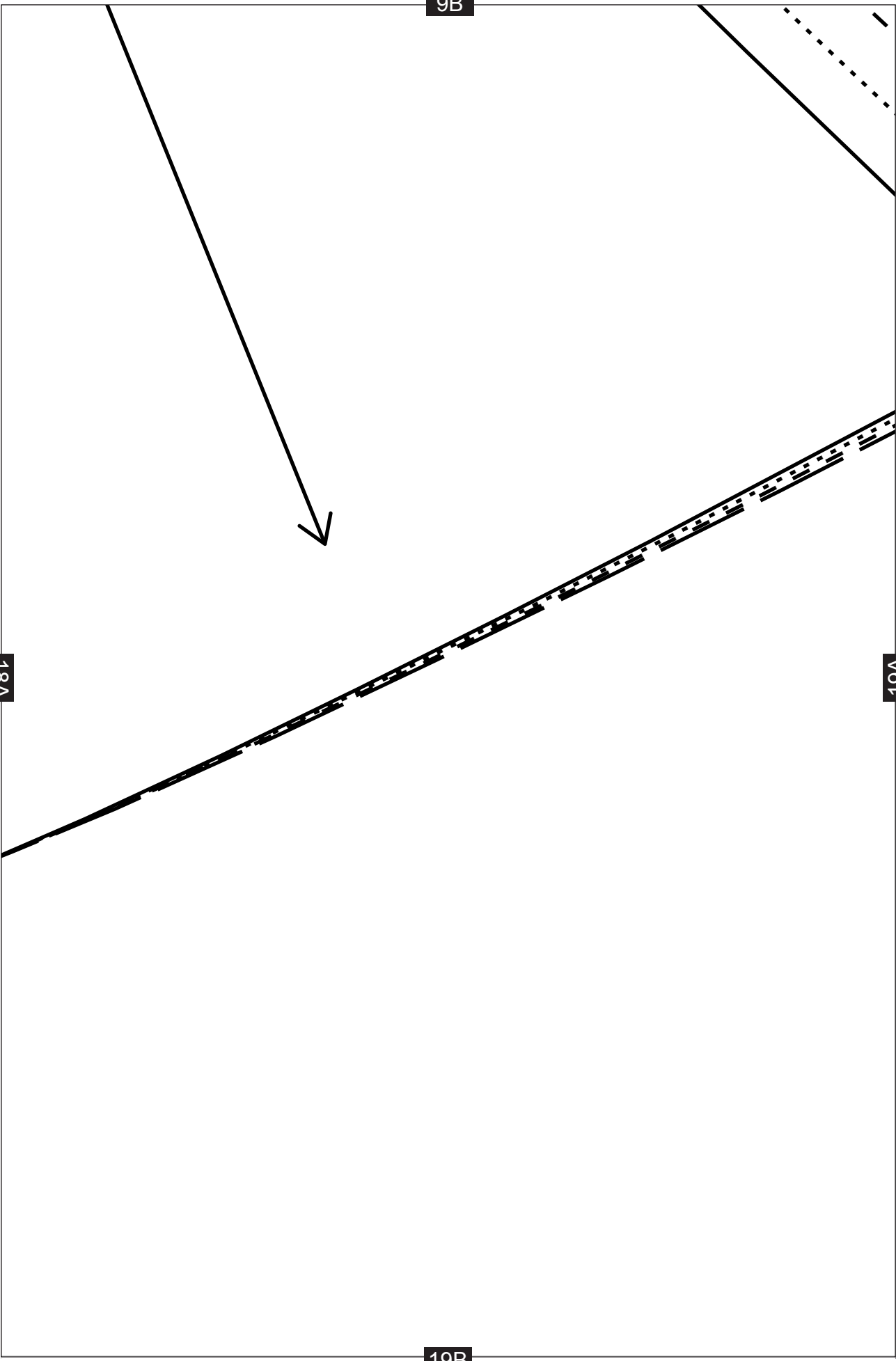

10B

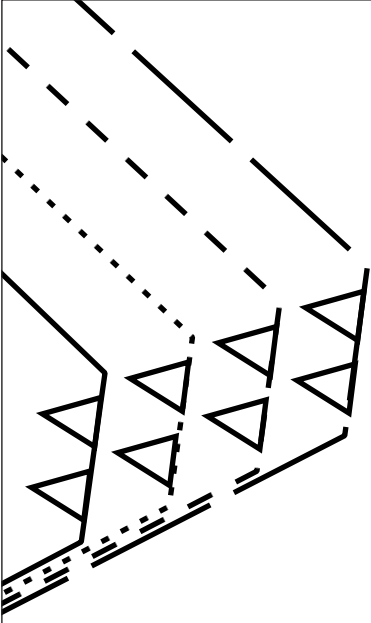

19A

20B

11B

21A

21B

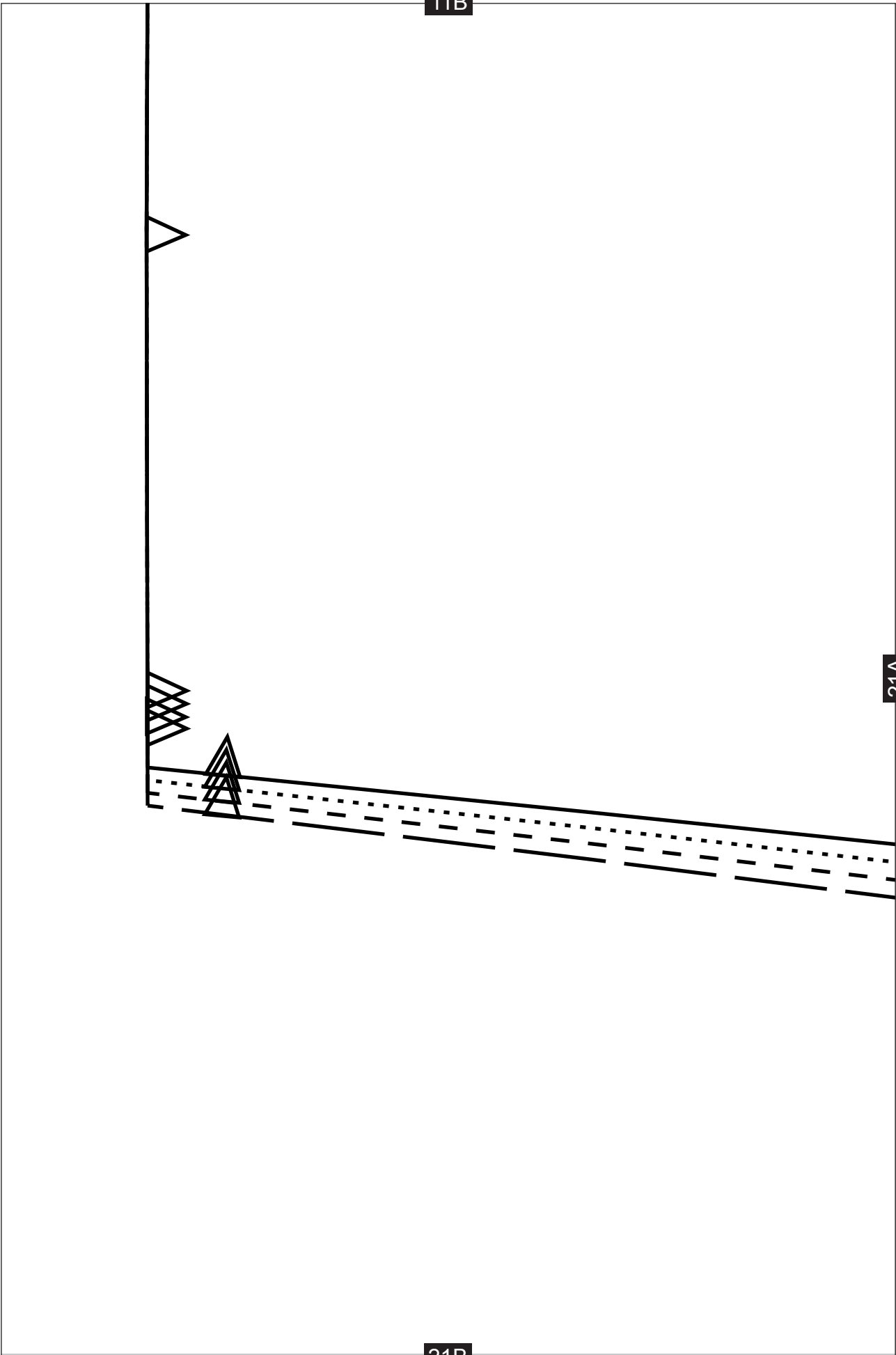

12B



FADEN

21A

22A

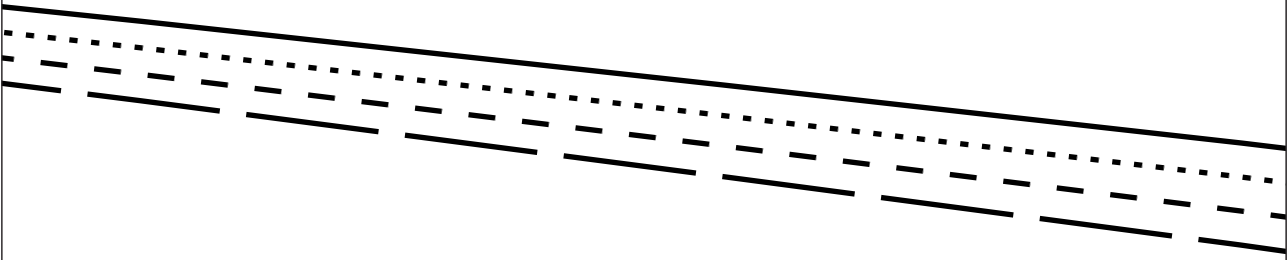

22B

13B

LAUF

MÄNNERJOGGING RÜCKENTEIL

22A

23A

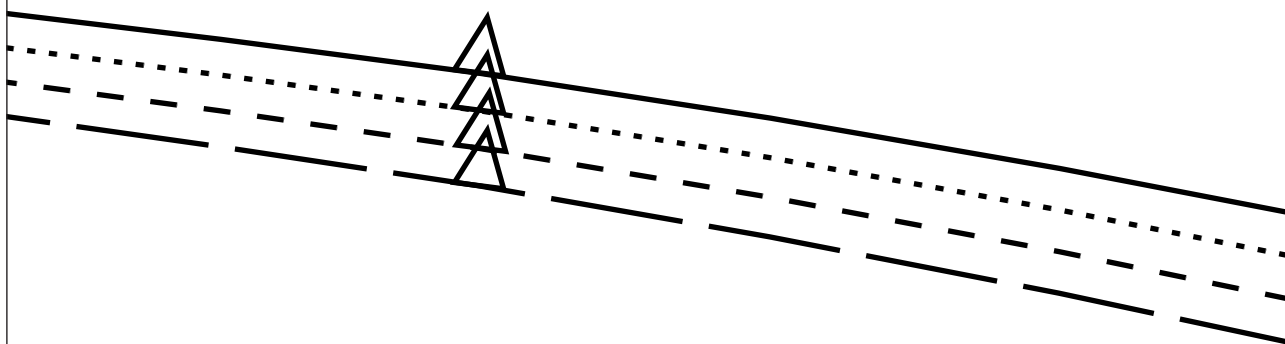

23B

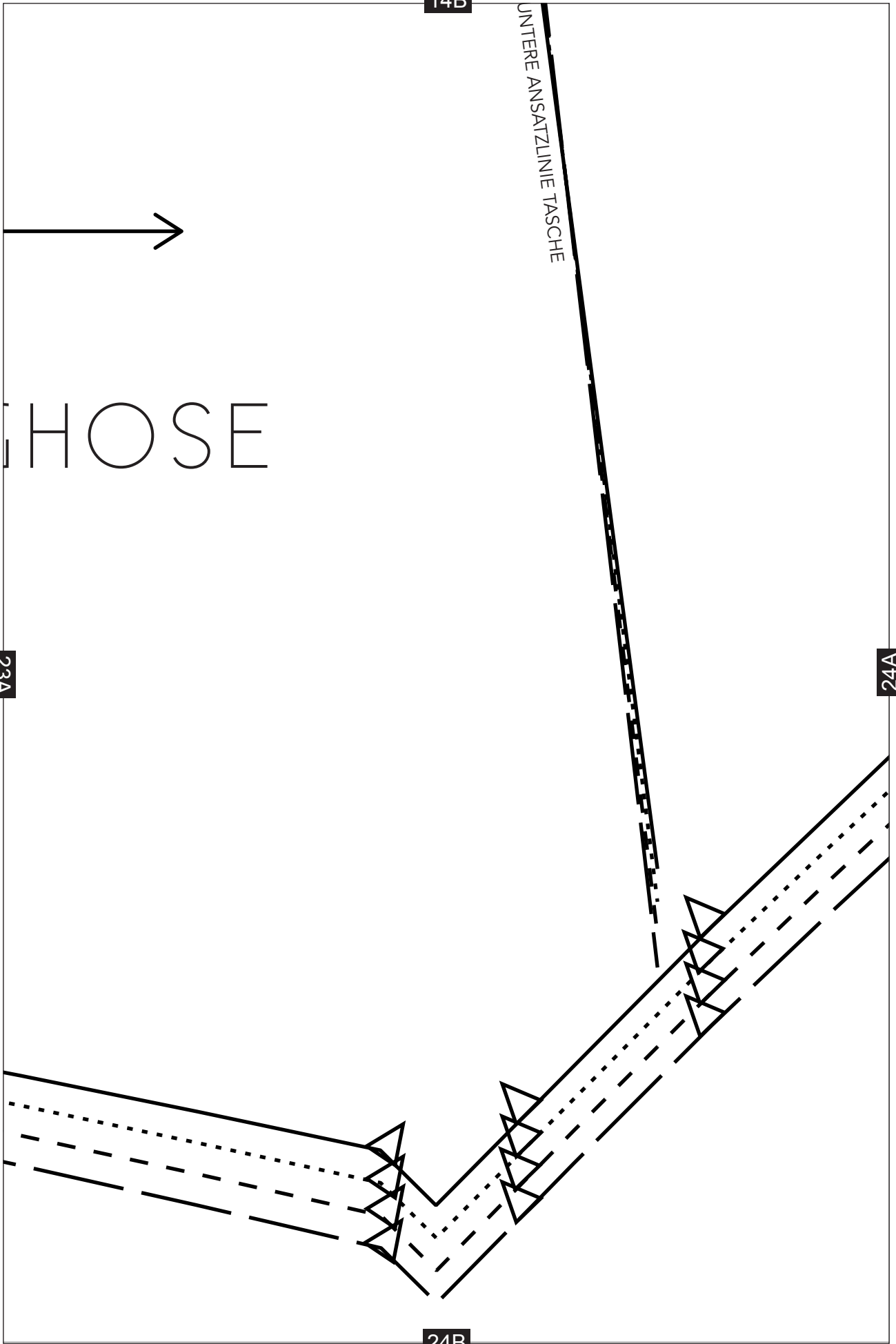

15B

24A

25A

25B

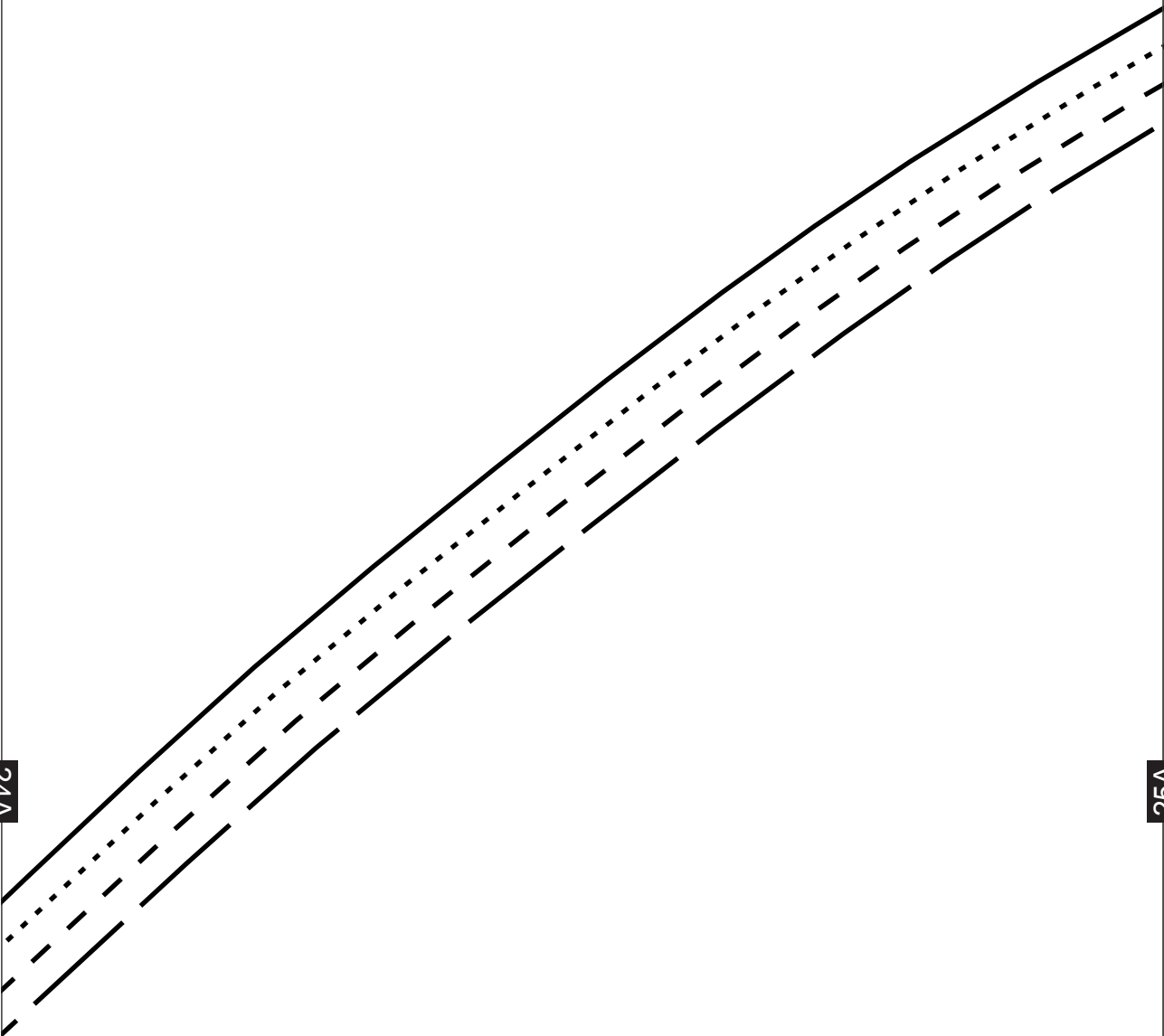

16B

ERE MITTE

GINGHOSE



25A

26A

26B

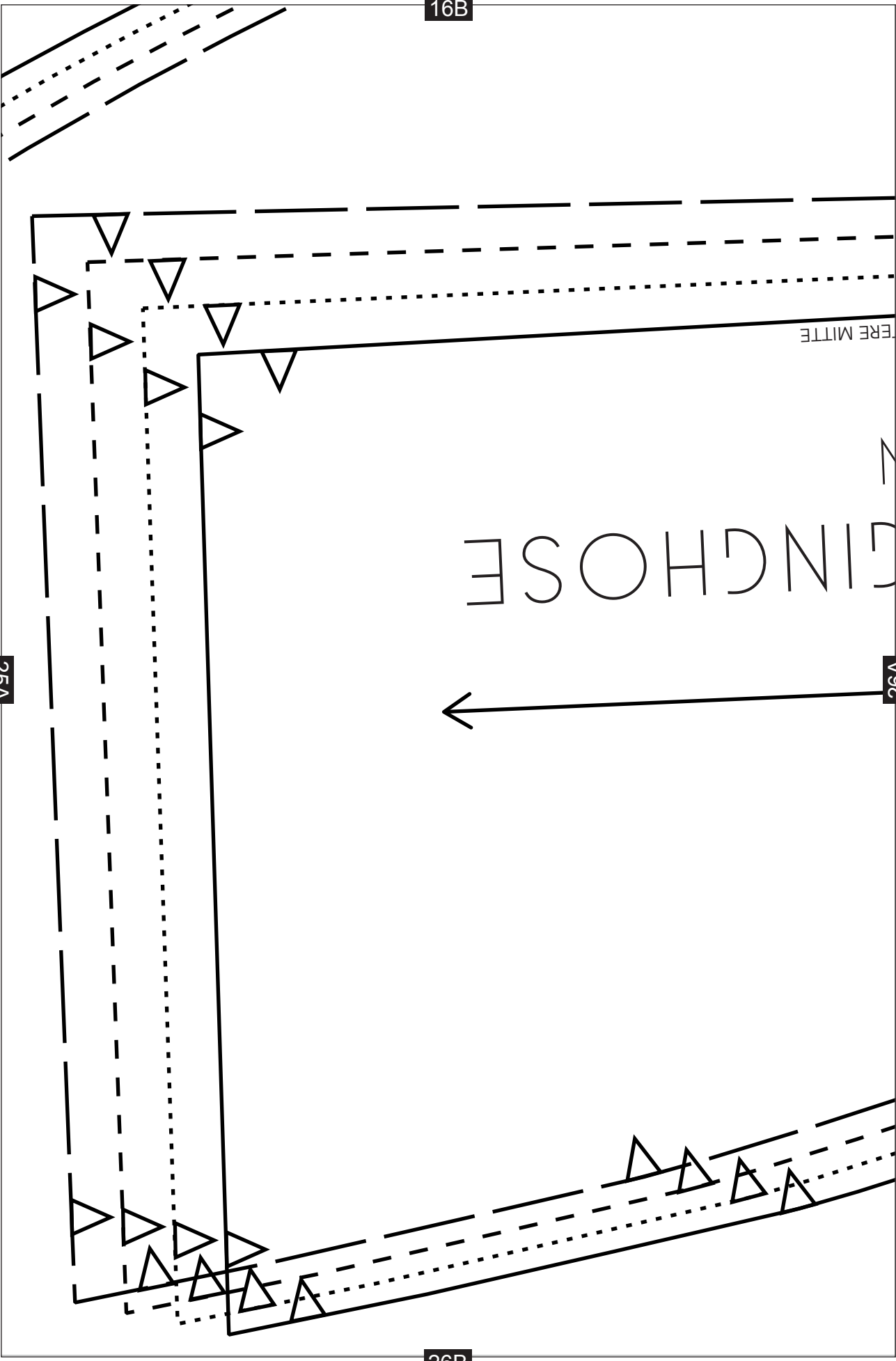

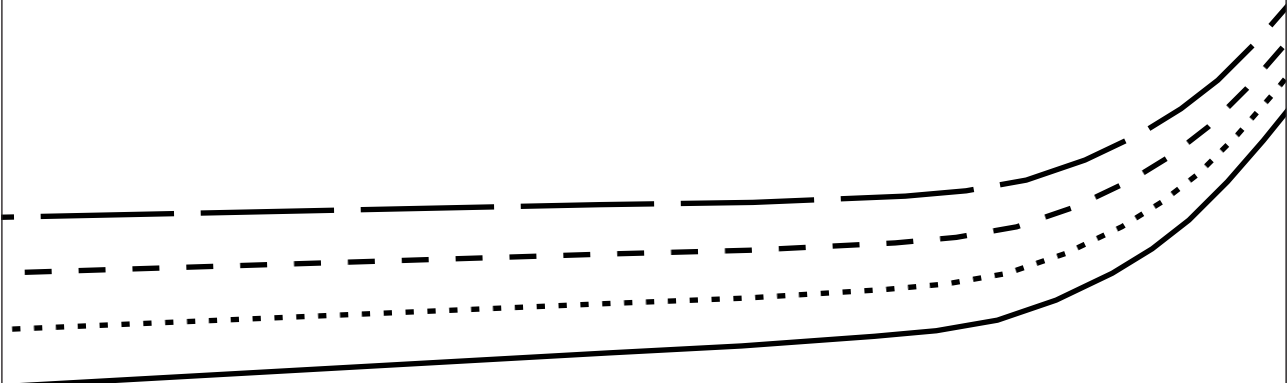

HINT

MÄNNER JOGG
 MITTELTEIL HINTEN

26A



FADENLAUF

27A

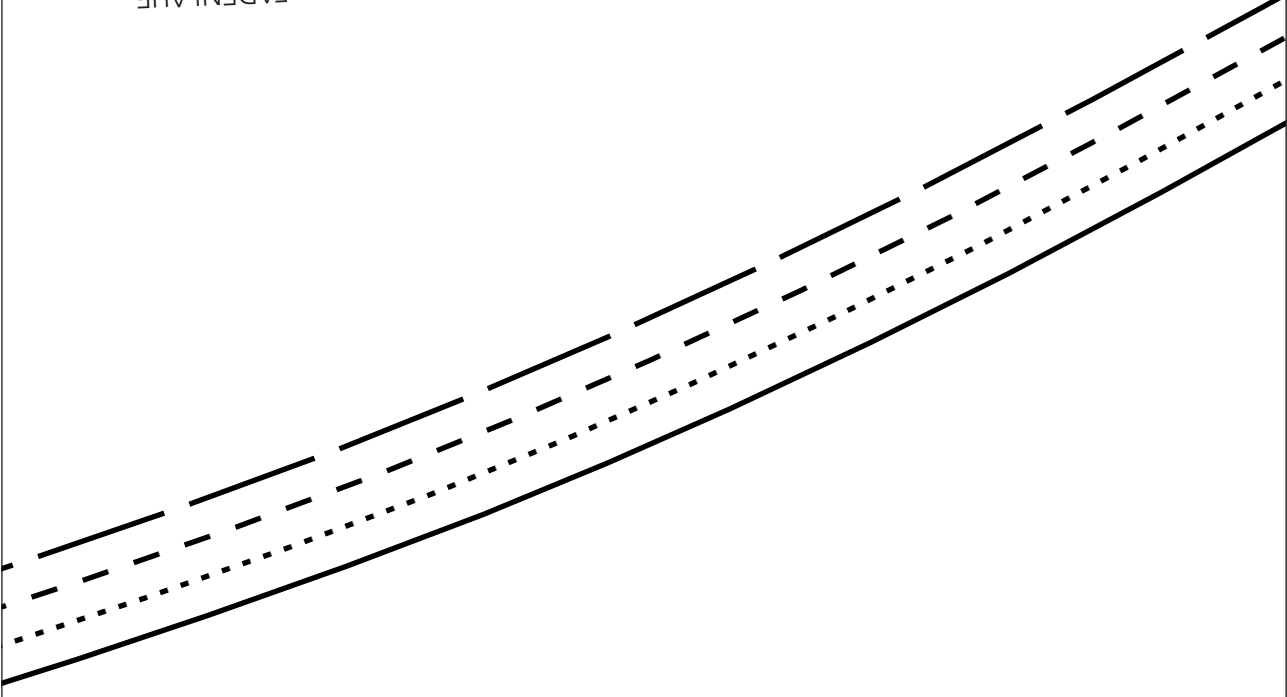

18B

7X
7
W
S

27A

28A

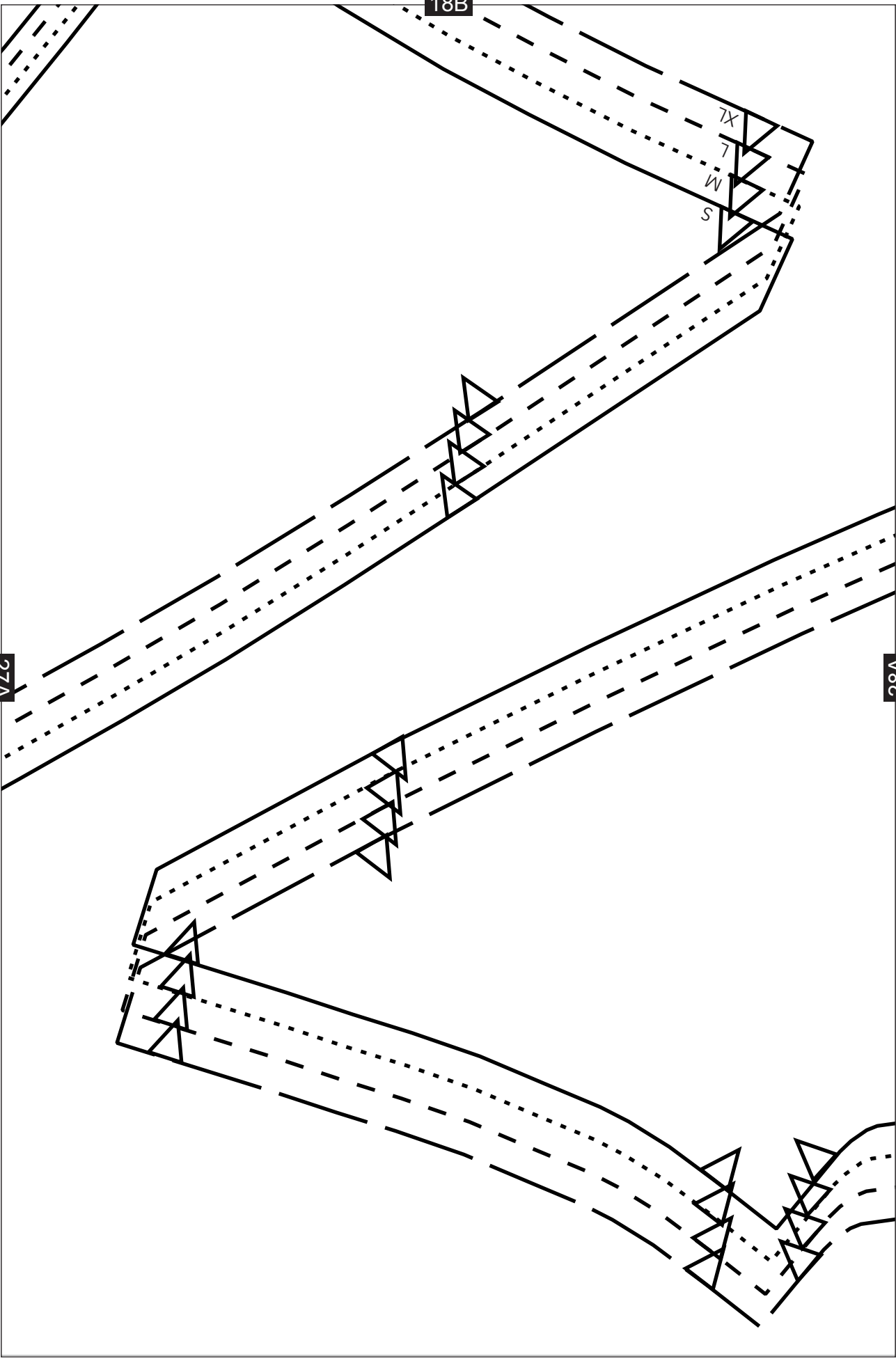



MÄNNER JO
MITTELTEIL VO

FADENLAUF

28A

29A

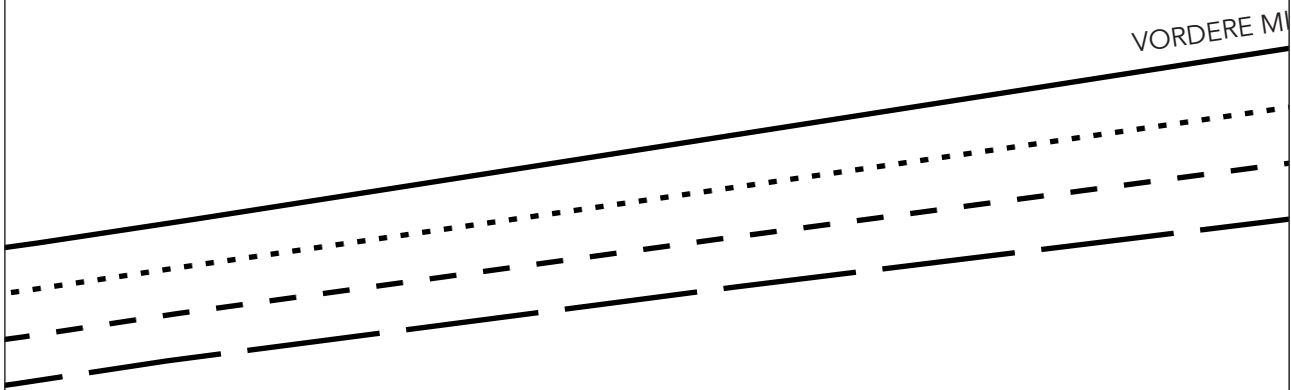

VORDERE MI

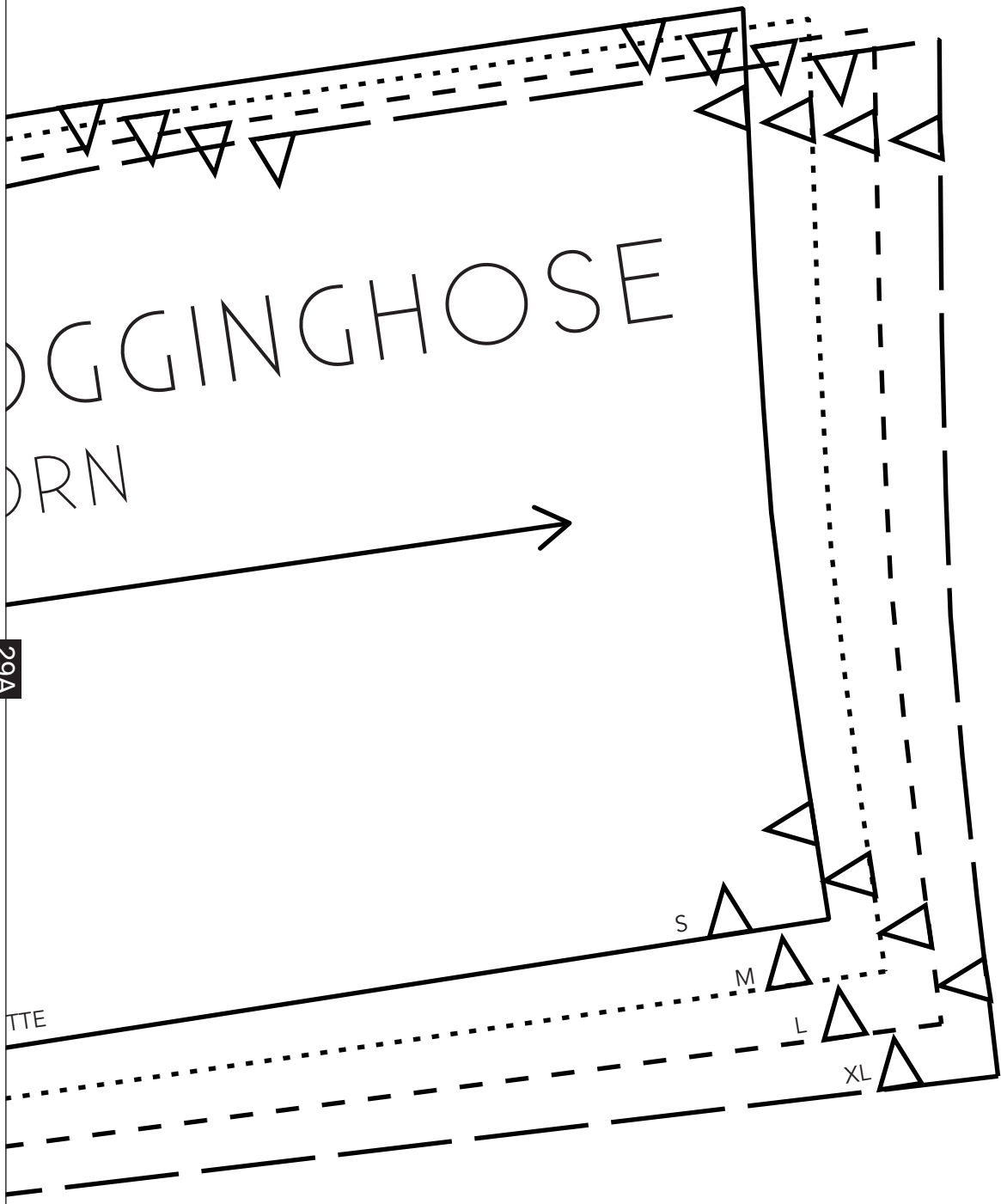

29A

TTE

S

M

L

XL

21B

31A

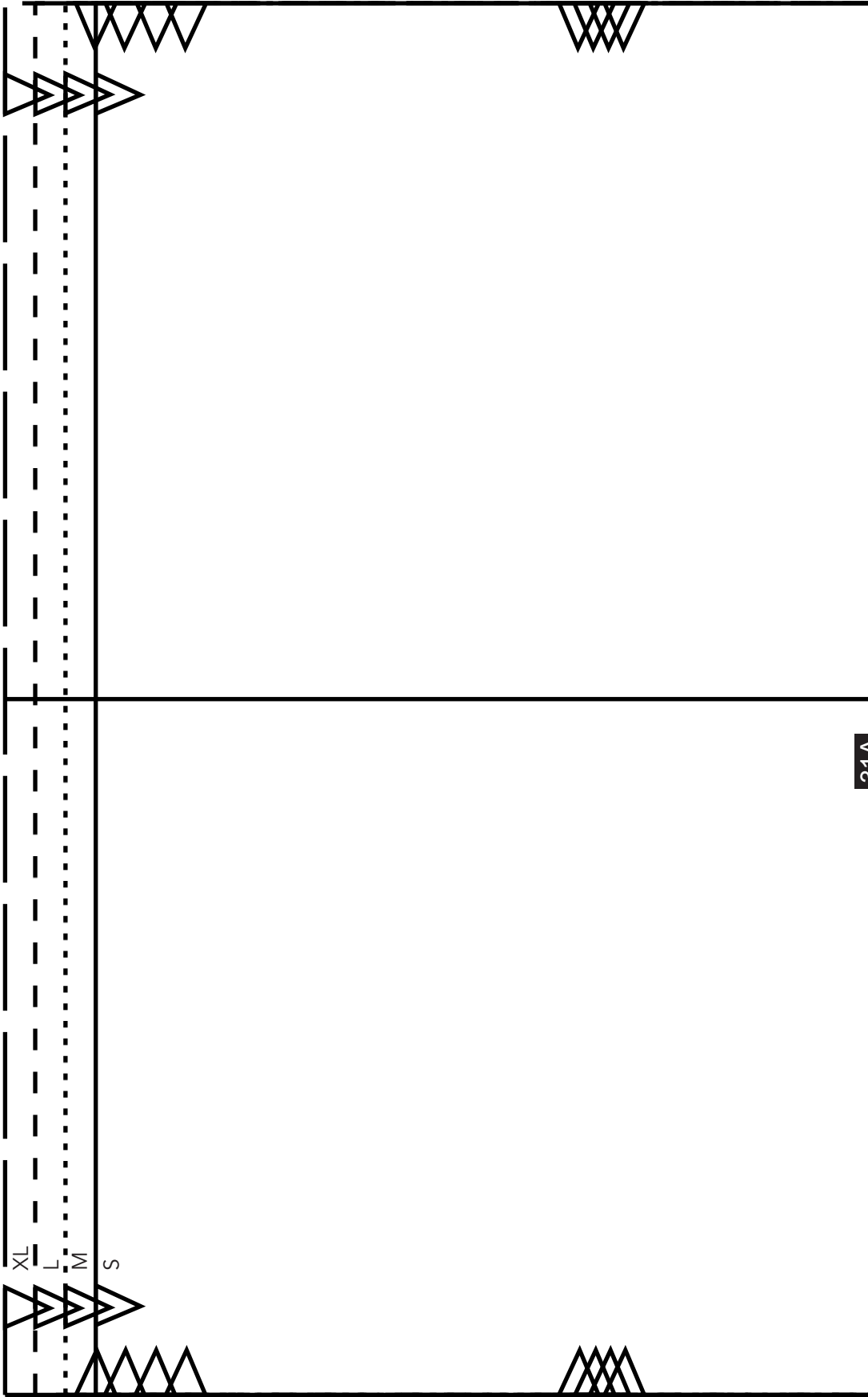

22B

MÄNNER-
JOGGINGHOSE
BÜNDCHEN BEIN

BRUCHLINIE

31A

32A

FADENLAUF



23B

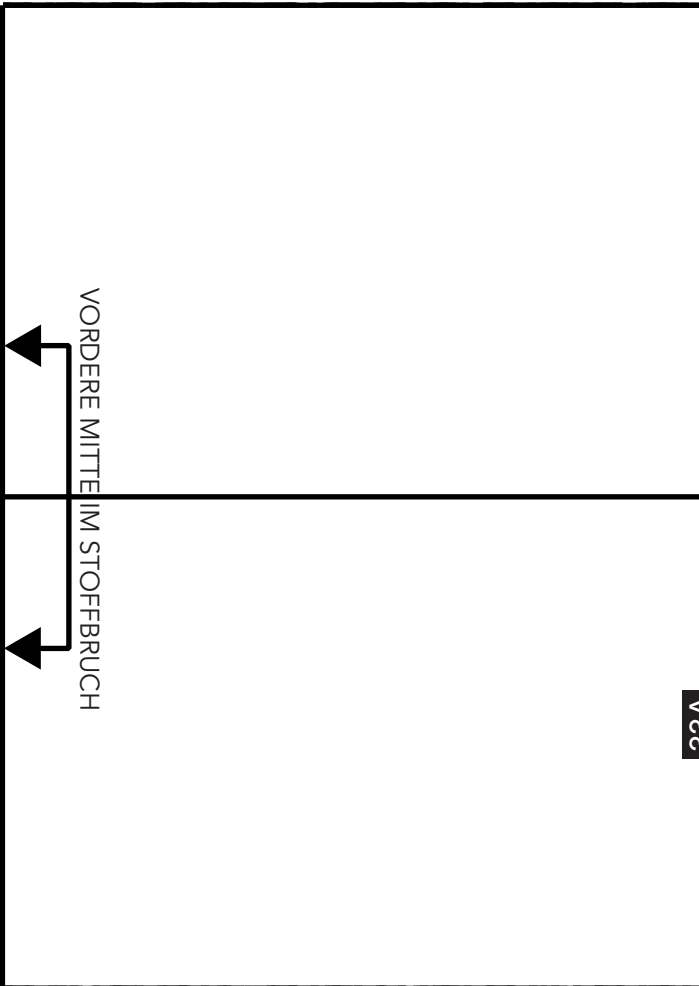

33A

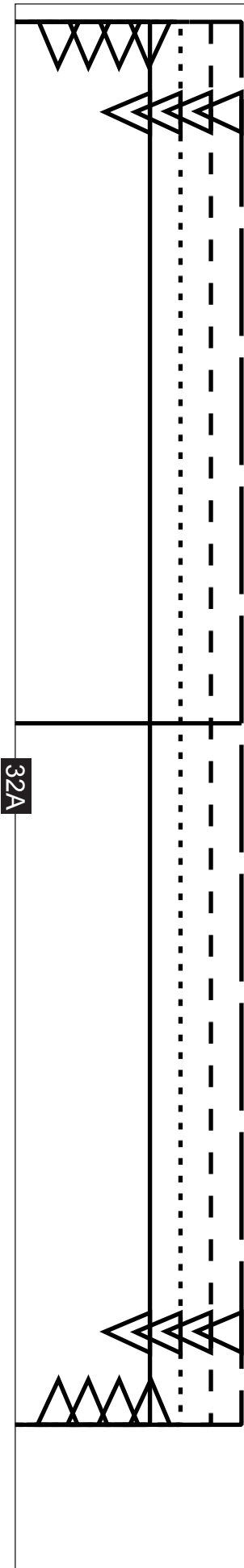

32A

24B

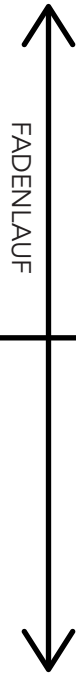

34A

GINGHOSE



33A

25B



BRUCHLINIE

MÄNNER JOO
TAILLENBÜNDCHEN

34A

35A



